

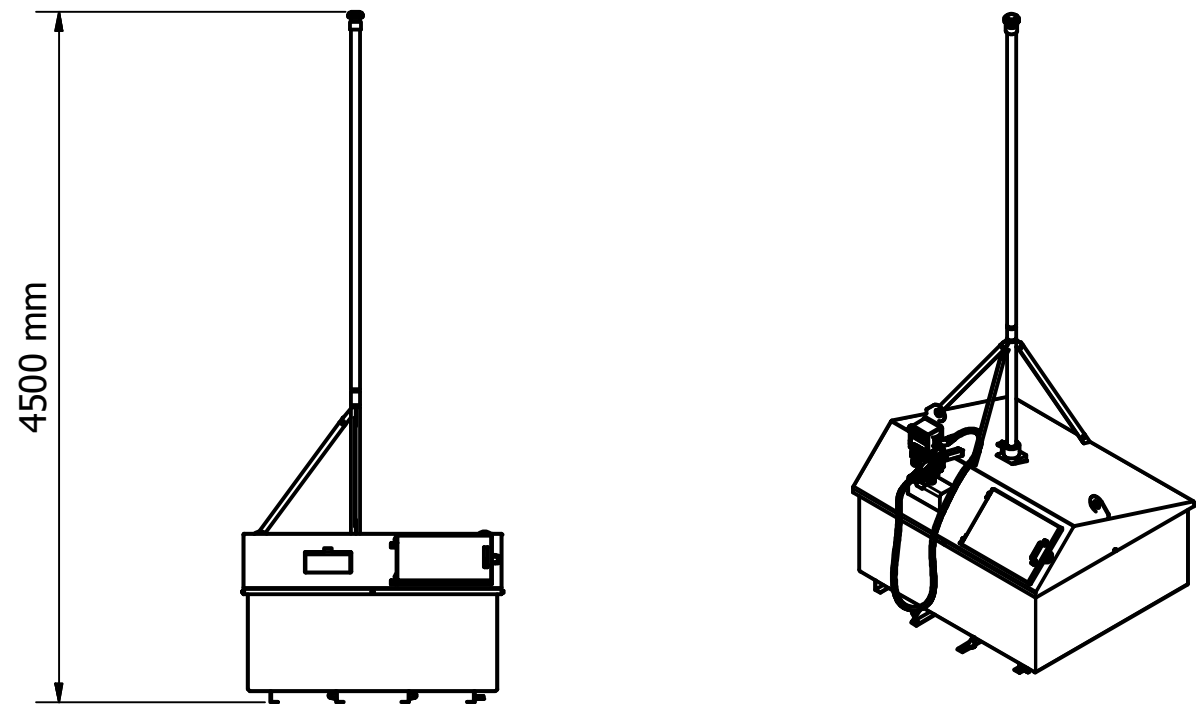

1250 PT

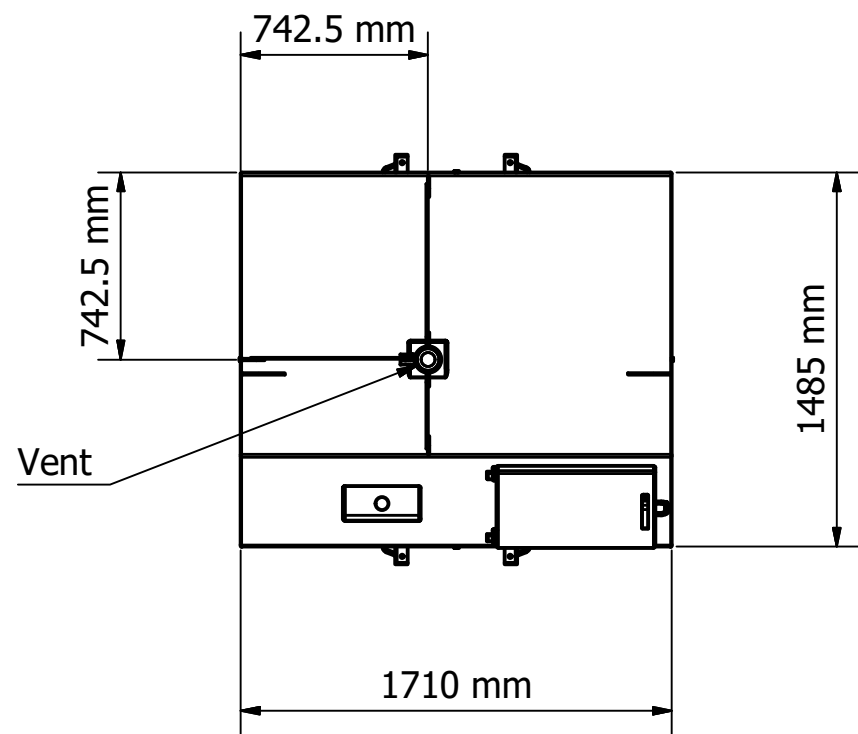
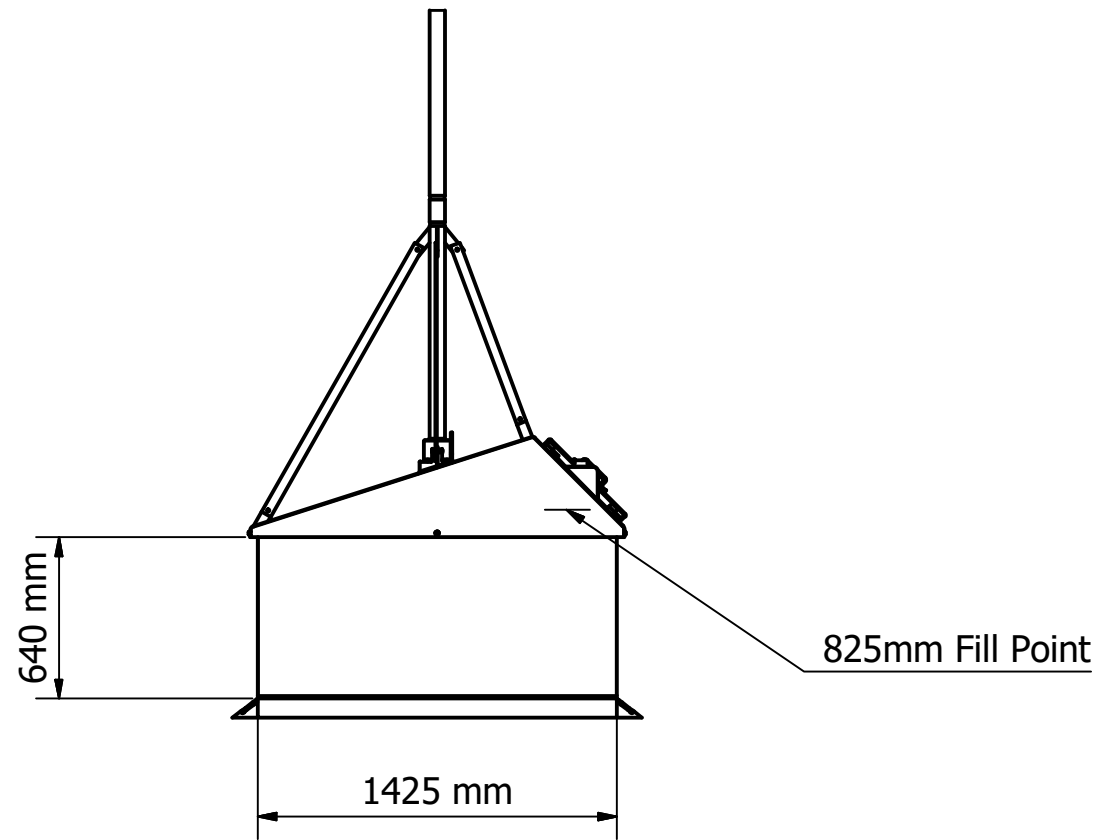
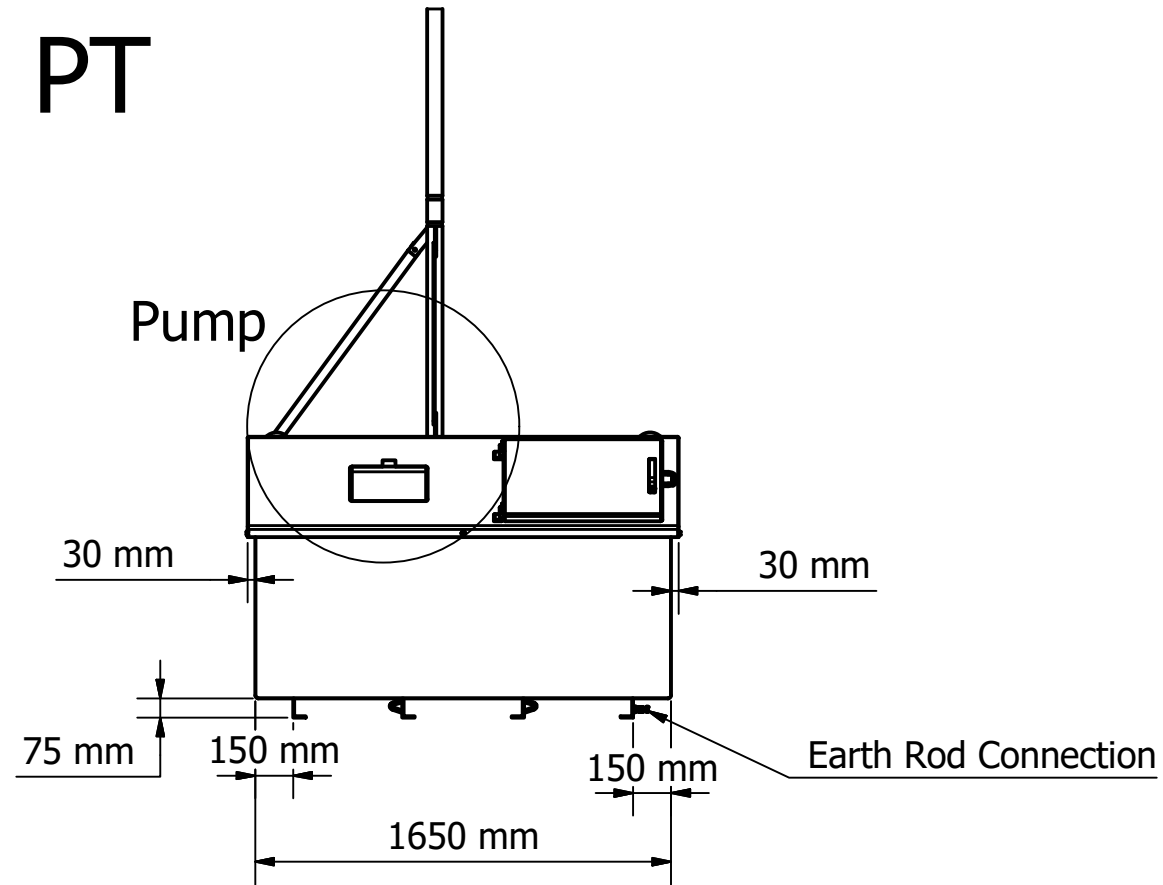

DESIGNED BY Rob Smith	CHECKED BY J Shenton	APPROVED BY	DATE	DATE 23/01/2019
		1250 PT		
		Weight - 795 Kgs	ISSUE A	SHEET 1 / 1