

2500 PT

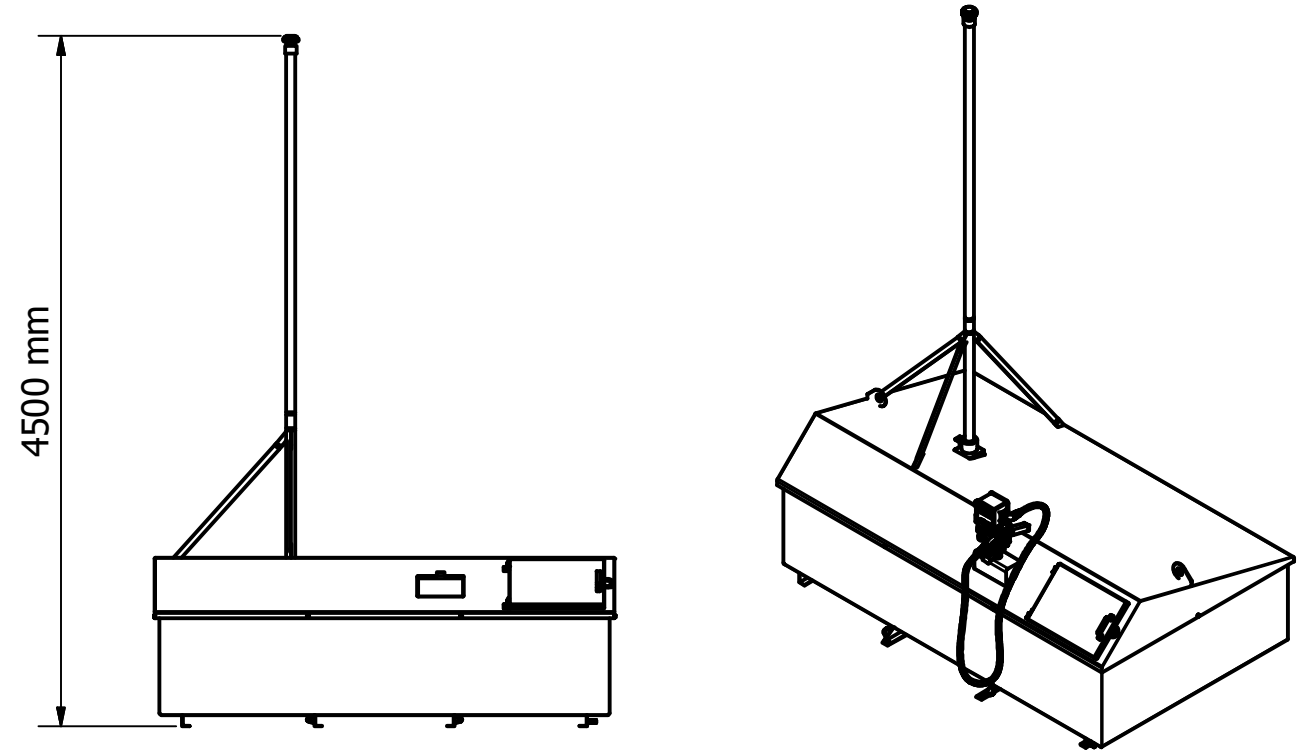
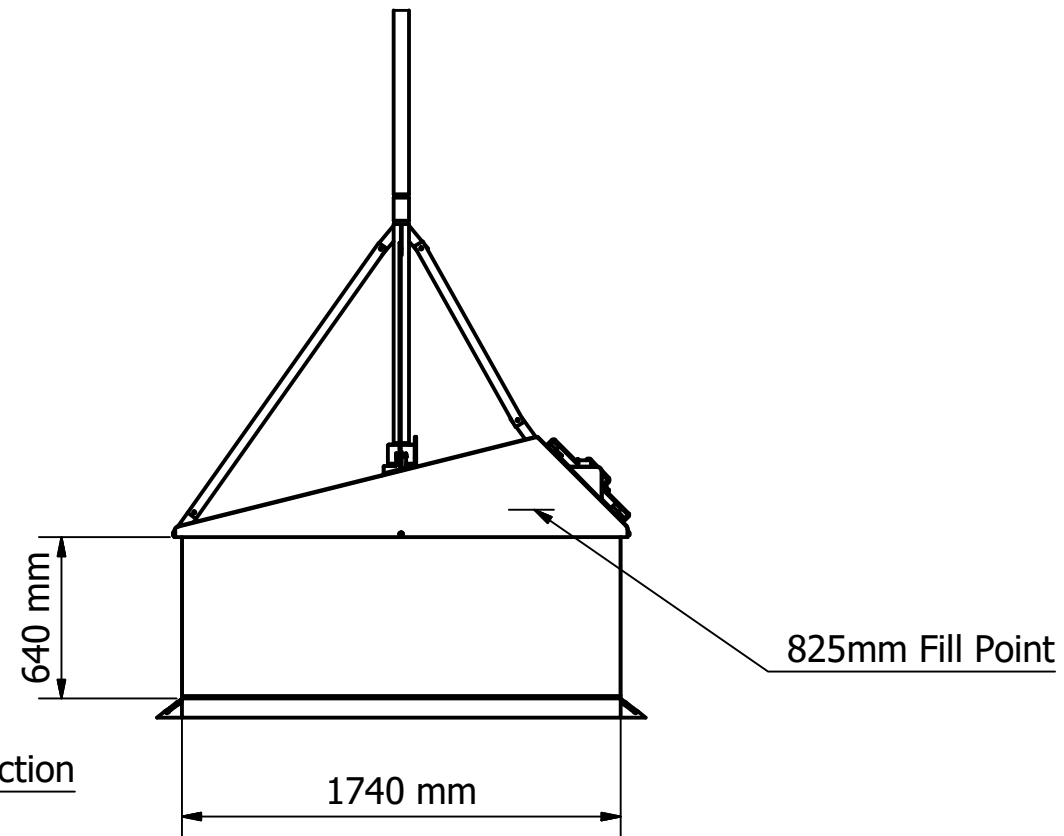
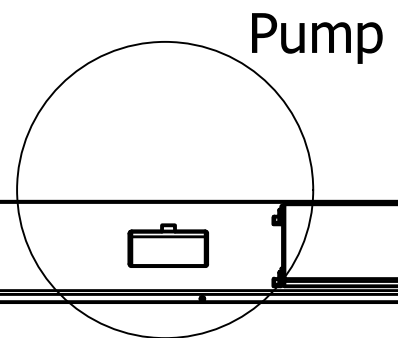
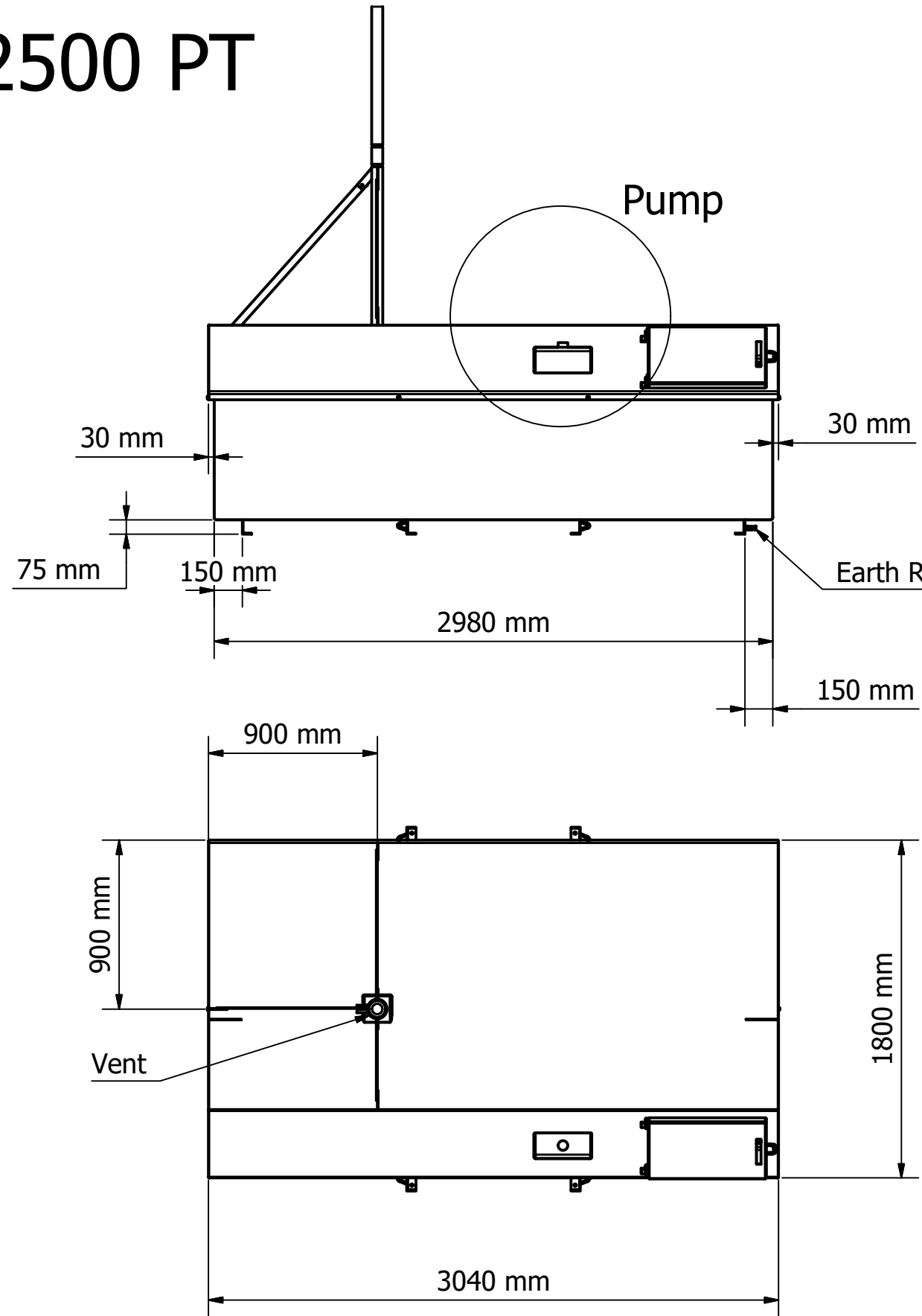

DESIGNED BY Rob Smith	CHECKED BY J Shenton	APPROVED BY	DATE	DATE 23/01/2019
		2500 PT		
		Weight - 1160 Kgs	ISSUE A	SHEET 1 / 1